

Keysight N432A Thermistor Power Meter

NOTICE: This document contains references to Agilent Technologies. Agilent's former Test and Measurement business has become Keysight Technologies. For more information, go to www.keysight.com.



Notices

© Keysight Technologies 2010–2014

No part of this manual may be reproduced in any form or by any means (including electronic storage and retrieval or translation into a foreign language) without prior agreement and written consent from Keysight Technologies as governed by United States and international copyright laws.

Manual Part Number

N432A-90005

Edition

Edition 6, August 2014

Keysight Technologies
1400 Fountaingrove Parkway
Santa Rosa, CA 95403

Warranty

The material contained in this document is provided “as is,” and is subject to being changed, without notice, in future editions. Further, to the maximum extent permitted by applicable law, Keysight disclaims all warranties, either express or implied, with regard to this manual and any information contained herein, including but not limited to the implied warranties of merchantability and fitness for a particular purpose. Keysight shall not be liable for errors or for incidental or consequential damages in connection with the furnishing, use, or performance of this document or of any information contained herein. Should Keysight and the user have a separate written agreement with warranty terms covering the material in this document that conflict with these terms, the warranty terms in the separate agreement shall control.

Technology Licenses

The hardware and/or software described in this document are furnished under a license and may be used or copied only in accordance with the terms of such license.

Restricted Rights Legend

U.S. Government Restricted Rights. Software and technical data rights granted to the federal government include only those rights customarily provided to end user customers. Keysight provides this customary commercial license in Software and technical data pursuant to FAR 12.211 (Technical Data) and 12.212 (Computer Software) and, for the Department of Defense, DFARS 252.227-7015 (Technical Data - Commercial Items) and DFARS 227.7202-3 (Rights in Commercial Computer Software or Computer Software Documentation).

Safety Notices

CAUTION

A **CAUTION** notice denotes a hazard. It calls attention to an operating procedure, practice, or the like that, if not correctly performed or adhered to, could result in damage to the product or loss of important data. Do not proceed beyond a **CAUTION** notice until the indicated conditions are fully understood and met.

WARNING

A **WARNING** notice denotes a hazard. It calls attention to an operating procedure, practice, or the like that, if not correctly performed or adhered to, could result in personal injury or death. Do not proceed beyond a **WARNING** notice until the indicated conditions are fully understood and met.

Certification

Keysight Technologies certifies that this product met its published specifications at the time of shipment. Keysight further certifies that its calibration measurements are traceable to the United States National Institute of Standards and Technology (formerly National Bureau of Standards), to the extent allowed by that organization calibration facility, and to the calibration facilities of other International Standards Organization members.

Limitation of Warranty

The foregoing warranty shall not apply to defects resulting from improper or inadequate maintenance by Buyer, Buyer-supplied software or interfacing, unauthorized modification or misuse, operation outside of the environmental specifications for the product, or improper site preparation or maintenance. No other warranty is expressed or implied. Keysight Technologies specifically disclaims any implied warranty or condition of merchantability, fitness for a particular purpose, or satisfactory quality.

Exclusive Remedies

To the extent allowed by local law, the remedies provided herein are the Buyer's sole and exclusive remedies. Keysight shall not be liable for any direct, indirect, special, incidental, or consequential damages (including lost profit or data), whether based on warranty, contract, tort, or any other legal theory.

Equipment Operation

Warnings and Cautions

This guide uses warnings and cautions to denote hazards.

WARNING

A **WARNING** notice denotes a hazard. It calls attention to an operating procedure, practice, or the like that, if not correctly performed or adhered to, could result in personal injury or loss of life. Do not proceed beyond a **WARNING** notice until the indicated conditions are fully understood and met.

CAUTION

A **CAUTION** notice denotes a hazard. It calls attention to an operating procedure, practice, or the like that, if not correctly performed or adhered to, could result in damage to the product or loss of important data. Do not proceed beyond a **CAUTION** notice until the indicated conditions are fully understood and met.

Personal safety considerations

This is a Safety Class I instrument (provided with a protective earthing ground, incorporated in the power cord). The mains plug shall only be inserted in a socket outlet provided with a protective earth contact. Any interruption of the protective conductor inside or outside of the instrument is likely to damage the instrument. Intentional interruption is prohibited. If the instrument is not used as specified, the protection provided by the instrument could be impaired. The instrument must be used in a normal condition (in which all means of protection are intact) only. No operator serviceable parts inside. Only refer servicing to qualified personnel. To prevent electric shock, do not remove covers. For continued protection against fire, replace the line fuse(s) only with fuses of the same type and rating (for example, normal blow, time delay, and so on). The use of other fuses or material is prohibited.

General Safety Considerations

The following general safety precautions must be observed during all phases of operation of the instrument. Failure to comply with these precautions or with specific warnings elsewhere in this manual violates safety standards of design, manufacture, and intended use of the instrument. Keysight Technologies assumes no liability for the customer's failure to comply with these requirements.

WARNING

















Before the instrument is switched on, make sure that it has been properly grounded through the protective conductor of the AC power cable to a socket outlet provided with protective earth contact. Any interruption of the protective (grounding) conductor inside or outside of the instrument, or disconnection of the protective earth terminal can result in personal injury.

CAUTION





Any adjustments or service procedures that require operation of the instrument with protective covers removed should be performed only by trained service personnel.

Safety Symbols

The following symbols on the instrument and in the documentation indicate precautions which must be taken to maintain safe operation of the instrument.

	Caution, risk of danger. The Instruction Documentation Symbol. The instrument is marked with this symbol when it is necessary for the user to refer to the instructions in the supplied documentation.		This symbol indicates the operating switch for 'Stand-by' mode. Note, this instrument is NOT isolated from the mains when the switch is pressed. To isolate the instrument, the mains coupler (mains input cord) should be removed from the power supply.
	Alternating current (AC)		Instrument protected throughout by DOUBLE INSULATION or RE-INFORCED INSULATION
	Direct current (DC)		On (Supply)
	Both direct and alternating current		Off (Supply)
	Three-phase alternating current		Caution, risk of electric shock
	Earth (ground) TERMINAL		Caution, hot surface
	PROTECTIVE CONDUCTOR TERMINAL		In position of bi-stable push control
	Frame or chassis TERMINAL		Out position of bi-stable push control
	Equipotentiality		

Regulatory Markings

	<p>The CE mark shows that the product complies with all the relevant European legal Directives (if accompanied by a year, it signifies when the design was proven)</p>		<p>The CSA mark is a registered trademark of the Canadian Standards Association</p>
	<p>This is the symbol of an Industrial Scientific and Medical Group 1 Class A product</p>		<p>External Protective Earth Terminal.</p> <p>While this is a Class I product, provided with a protective earthing conductor in a power cord, an external protective earthing terminal has also been provided. This terminal is for use where the earthing cannot be assured. At least an 18AWG earthing conductor should be used in such an instance, to ground the instrument to an assured earth.</p>

IEC 1010-1 compliance

This instrument has been designed and tested in accordance with IEC Publication 1010-1 +A1:1992 Safety Requirements for Electrical Equipment for Measurement, Control and Laboratory Use and has been supplied in a safe condition. The instruction documentation contains information and warnings which must be followed by the user to ensure safe operation and to maintain the instrument in a safe condition.

Statement of compliance

This product has been designed and tested for compliance with IEC 60529 (1989) Degrees of Protection Provided by Enclosures (IP Code). Level IPx4 is attained if, and only if, the carry case (Keysight part number 34141A) is fitted.

In This Guide...

1 N432A at a Glance

This chapter provides an overview of the N432A front and rear panels as well as display outlook.

2 Calibration Procedures

This chapter describes how to carry out performance verification and adjustment on the N432A to ensure proper performance.

3 Service and Maintenance

This chapter provides the information on performing general service and maintenance for the N432A.

4 Disassembly Guide

This chapter guides you to remove and replace the assemblies in the N432A. It also lists the available N432A replacement parts together with their part numbers, as well as provides general troubleshooting hints.

5 Specifications and Characteristics

This chapter lists the specifications and characteristics of the N432A.

Contents

- 1 N432A at a Glance 1**
 - Front Panel Outlook 2
 - Rear Panel Connections 7
 - Display Layout 8

- 2 Calibration Procedures 13**
 - Introduction 14
 - Keysight Technologies Calibration Services 14
 - Calibration Interval 14
 - Self-Test 15
 - Front panel selection of self-tests 15
 - Instrument self-test 15
 - Test descriptions 17
 - Remote testing 18
 - Performance Verification and Adjustments 19

- 3 Service and Maintenance 21**
 - Introduction 22
 - Service-Related Features 22
 - Cleaning 23
 - Checking the Power Line Fuses 23

- 4 Disassembly Guide 25**
 - Introduction 26
 - General safety consideration 26
 - Replaceable Parts 28
 - Major assemblies 28
 - Front panel subassemblies 29
 - Power supply unit (PSU) subassemblies 32
 - Rear panel subassemblies 32
 - Other subassemblies 33

Tools Required	36
Required Torque Values	37
Disassembly Instructions	38
To remove the top clamshell	38
To remove the power supply unit (PSU)	39
To remove the front panel assembly	40
To remove the measurement board	41
To remove the PPMC assembly	42
To remove the fan assembly	43
To remove the motherboard	43
Reassembly Instructions	46
Front Panel Disassembly Instructions	47
Front Panel Reassembly Instructions	51
Improved Calibrator Assembly	54
Rear Panel Disassembly Instructions	55
Operating Checklist and Troubleshooting Hints	56
General problems	56
Instrument self-test failures	57
Extended self-test failures	58
Performance test failure	58

5 Specifications and Characteristics 59

Introduction	60
Specification definitions	60
N432A Specifications	62
Rear Panel Input and Output Connections	64
Line power	64
1 mW Power Reference	65
Environmental Conditions	66
General	66
Operating environment	66
Storage	66
Physical Characteristics	67

Dimensions	67
Weight	67
Regulatory Information	68
Electromagnetic (EM) compatibility	68
Product safety	68
Low voltage directive	68

THIS PAGE HAS BEEN INTENTIONALLY LEFT BLANK.

List of Figures

- Figure 1-1 Dual numeric display 8
- Figure 1-2 Single numeric and analog display 9
- Figure 1-3 Full screen numeric display 10
- Figure 2-1 Self-test completed 16
- Figure 2-2 V_{RF} , V_{COMP} , and V_0 tests skipped 17
- Figure 3-1 Checking the fuses 23
- Figure 4-1 Separate the clamshells 38
- Figure 4-2 Remove the top clamshell 38
- Figure 4-3 Remove the PSU safety cover and cable guide 39
- Figure 4-4 Remove the PSU 39
- Figure 4-5 Top view with top clamshell removed 40
- Figure 4-6 Remove the EMI earth wires 40
- Figure 4-7 Remove the front panel assembly 40
- Figure 4-8 Disconnect the sensor flex cable and V_{RF} and V_{COMP} cables 41
- Figure 4-9 Remove the measurement board 41
- Figure 4-10 Remove the PPMC assembly 42
- Figure 4-11 Remove the fan assembly 43
- Figure 4-12 Disconnect the calibrator assembly and front panel cables 43
- Figure 4-13 Disconnect the recorder cable and remove the earth cables and washers 44
- Figure 4-14 Remove the motherboard and rear panel assembly 44
- Figure 4-15 Remove the rear panel assembly 45
- Figure 4-16 Calibrator assembly and improved calibrator assembly 54

THIS PAGE HAS BEEN INTENTIONALLY LEFT BLANK.

Keysight N432A Thermistor Power Meter Service Guide

1 N432A at a Glance

Front Panel Outlook 2

Rear Panel Connections 7

Display Layout 8





This chapter provides an overview of the N432A front and rear panel outlook as well as its display layout.

Front Panel Outlook

This section briefly describes the functions of the front panel keys and connectors.



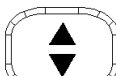
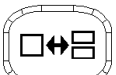





These keys are located to the left of the display.

Key	Function
	Press this key to preset the N432A to its default state
	Press this key to control the N432A from the front panel when it is operating via the remote interfaces (when Local Lock Out is disabled)
	Press this key to select the upper or lower measurement window. The selected window is highlighted by a blue line on the right of the window. Any measurement setup you create is performed in the selected window.
	Press this key to select a windowed, expanded, or full-screen display of a numeric measurement
	Press this key to switch the N432A between on and standby. When power is supplied, the background LED turns red. Pressing the key switches on the N432A and the background LED turns yellow. When the N432A is powered on, the startup will take approximately 25 seconds.



These keys are located along the lower edge of the display.

Key	Function
 System	Press this key to access general configuration menus, such as the remote interface configuration. You can also access some measurement configuration menus. The measurement screen remains visible.
 Channel	Press this key to access the channel configuration menu. Channel parameters such as voltage averaging and offsets are configured from this menu.
 Trig/Acq	Press this key to access the triggering menu
 Meas	Press this key to configure measurements for the selected measurement window, such as display offsets and relative measurements
 Display	Press this key to access the measurement display menu. You can select the displayed measurement resolution, unit, and display format. Use this key together with  Meas to configure measurement displays.

1 N432A at a Glance

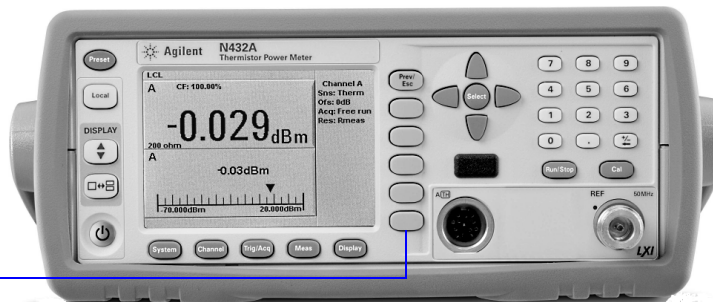



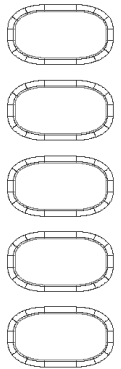
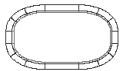

These keys are associated with the menu labels and data entry. They are located to the right of the display.

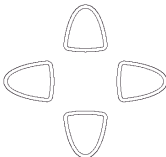

Key	Function
	Press this key to return to the previous screen. This key also cancels pop-up entries.
	<p>These unmarked keys are called 'softkeys' and are referred to by the text on the display next to them.</p> <p>For example, during a preset, you are given an option to confirm the command. Press Confirm to continue, that is, press the softkey beside the displayed word Confirm.</p>
	The lowest of the unmarked softkeys is used when there is a two-page menu to be displayed. For example, a 1 of 2 is displayed beside the key indicating the first page of a two-page menu. Press the key to access the next page or the second page (a 2 of 2 is displayed).

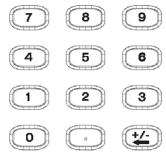

These keys and connectors are associated with the measurement channel and are located on the right of the front panel.

Key	Function
	The arrow keys are used for navigation around the parameter entry screens. The up and down arrows are used for selecting values from a pop-up list. They are also used to enter text such as table names.
	Press this key to select a highlighted field to allow data entry, select a check box, or confirm the entry of a pop-up list
	Press this key to access the zeroing menu
	Press this key to reset the MAX HOLD and MIN HOLD measurements
	Press these keys to enter numeric values in the pop-up fields, for example, the offset values. To complete the entry, use the softkey.

1 N432A at a Glance

Connector	Function
 A close-up photograph of a silver metal connector. The top left corner has the text 'REF' and the top right corner has '50 MHz'. The bottom right corner has 'LXI'. A small yellow LED is visible on the left side of the connector's face.	The power reference is a 1 mW (0 dBm), 50 MHz signal available from a 50 Ω type-N connector. It is used for calibrating a 478A or 8478B thermistor sensor and meter system. The yellow LED beside the connector is lit when turned on.
 A close-up photograph of a silver metal connector. The top left corner has the text 'A(TH)'. The connector has a circular opening with a dark interior.	Thermistor mount input connector for 1.5 m, 3 m, and 6.1 m cables that connect to the 478A or 8478B thermistor sensors

Rear Panel Connections

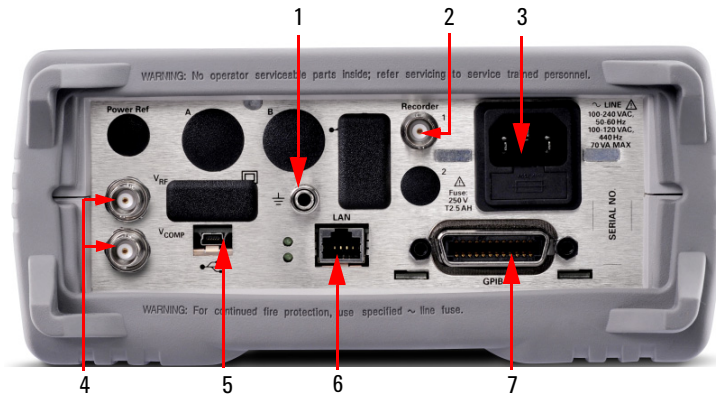

No.	Connection
1	Ground connector
2	Recorder output terminal 1 Recorder output connection is made via a BNC connector. This output produces a DC voltage that corresponds to the power level of the channel input.
3	AC inlet The N432A has an autoconfiguring power supply. This allows it to operate over a range of voltages without manually being set to a certain voltage.
4	V_{RF} and V_{COMP} output terminals The V_{RF} BNC terminal outputs the RF bridge voltage, while the V_{COMP} BNC terminal outputs the compensation bridge voltage. Both the V_{RF} and V_{COMP} outputs are used for calibrating the N432A and for precision power measurements.
5	USB Mini-B port Allows the N432A to be controlled remotely over the USB interface
6	LAN interface Allows the N432A to be controlled remotely over the LAN interface
7	GPIB interface Allows the N432A to be controlled remotely over the General Purpose Interface Bus (IEEE-488) standard interface

Display Layout

The following figure shows the display when two windows are configured in the dual numeric mode.

Other display formats are available by pressing  > **Disp Type**.

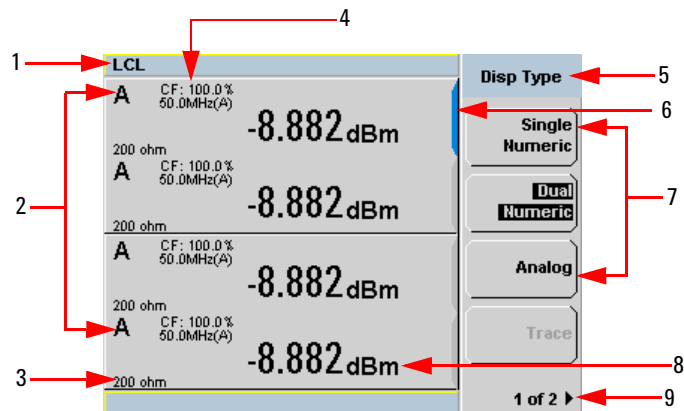

Figure 1-1 Dual numeric display

- 1 The status reporting line displays messages and the control status of the N432A.

For example, the status can be either **RMT** (remote, GPIB, USB, or LAN operation) or **LCL** (local, front panel operation). The message field will indicate **ERR** for any error conditions that occur.

- 2 The measured channel is shown with a thermistor sensor connected.
- 3 This field displays the current bridge resistance value as an indicator with or without the thermistor sensor connected.
- 4 The information in this field is displayed in two lines and depends on the sensor calibration factor, sensor calibration and frequency-dependent offset tables currently selected, and the measurement frequency.
- 5 This field displays the menu title.

For example, **Channel Setup**, or press  and the **Zero/Cal** menu is displayed.

- 6 The blue highlight on the right of the window indicates the currently selected measurement display line. This measurement line refers to the upper window/upper measurement.
- 7 The available softkey labels are displayed in these fields. Additionally, settings associated with the labeled function are displayed under the label. Softkey labels that are grayed out cannot be selected.
- 8 This displays the measurement unit.
- 9 This displays the number of pages in the current menu. For example, **1 of 2** indicates that there are two pages in the menu and the first page is currently displayed. Pressing the softkey displays the next page, indicated by **2 of 2** (press the softkey again to display the previous menu page).

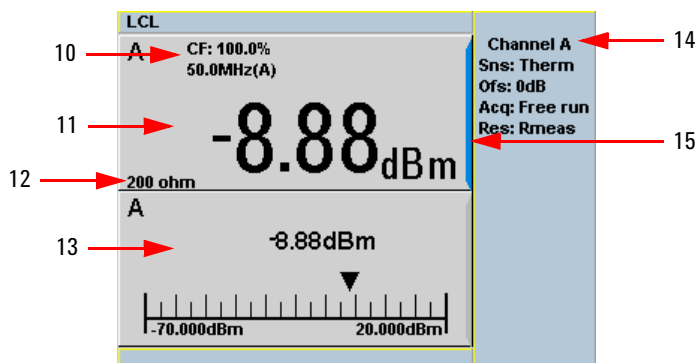



Figure 1-2 Single numeric and analog display

Figure 1-2 shows the default display format of two measurement windows in the single numeric and analog mode.

- 10 The information in this field is displayed in two lines and depends on the sensor calibration factor, sensor calibration and frequency-dependent offset tables currently selected, and the measurement frequency.
- 11 The upper window is configured to show a single numeric display.
- 12 This field displays the current bridge resistance value as an indicator with or without the thermistor sensor connected.
- 13 The lower window is configured to show an analog meter which displays the measurement result and the meter scaling.

14 This displays the connected sensor, offset value, acquisition mode, and bridge resistance type for the channel.

15 The blue highlight on the right of the window indicates the currently selected measurement display line.

Using the up/down arrow key or , you can change the measurement window selection.

Using  on a numeric measurement result window allows you to select either a single enlarged window or a full screen display. The display style is applied to the currently selected window or measurement line.

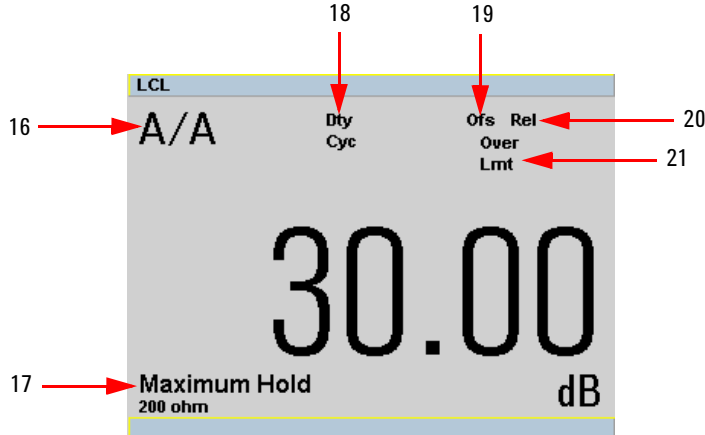

Figure 1-3 Full screen numeric display

Figure 1-3 shows a single numeric full screen displaying a relative result.

16 This field displays either a ratio or difference measurement indicator when the Combined measurement function is enabled.

17 This field displays either **Minimum Hold** or **Maximum Hold** if the range hold is set to minimum or maximum respectively.

18 This field displays **Dty Cyc** if a duty cycle is set.

19 This field displays **Ofs** if an offset is set.

20 This field displays **Rel** if relative mode is enabled.

21 This field indicates that the measurement result is beyond the configured upper or lower limit. If the measurement result is within the limits, this field is empty. If the measurement result is less than the minimum limit set, **Undr Lmt** is displayed. If the measurement result is more than the maximum limit set, **Over Lmt** is displayed.

THIS PAGE HAS BEEN INTENTIONALLY LEFT BLANK.

2 Calibration Procedures

Introduction	14
Keysight Technologies Calibration Services	14
Calibration Interval	14
Self-Test	15
Performance Verification and Adjustments	19

This chapter provides the information on performance verification and adjustment of the N432A which ensure that it is operating within its published specifications.

Introduction

This section provides the guidelines for verifying the performance of the N432A as well as carrying out the necessary adjustments. Performance verification tests allow you to verify that the N432A is operating within its published specifications. Adjustments are not usually required on any regular basis. They are normally performed only after a performance test has indicated that some parameters are out of specifications, or after repair.

Keysight Technologies Calibration Services

When your N432A is due for calibration, contact your local Keysight Service Center for a low-cost recalibration. The N432A is supported on an automated calibration and adjustment systems, which allow Keysight to provide this service at competitive prices.

To obtain warranty, service, or technical support information, you can contact Keysight at the telephone numbers listed in **Contact us** on the back page. You can also use the following web link for information on contacting Keysight worldwide:

www.keysight.com/find/assist

or contact your Keysight representative.

Before shipping your N432A, request the Keysight Service Center to provide shipping instructions, including what components to ship. Keysight recommends that you retain the original shipping carton for use in such shipments.

Calibration Interval

A one-year interval is adequate for most applications. Accuracy specifications are warranted only if calibration is made at regular calibration intervals. Accuracy specifications are not warranted beyond the one-year calibration interval. Keysight does not recommend extending calibration interval beyond the recommended calibration interval for any application.

Self-Test

NOTE

- Always ensure that the self-test passes before proceeding with any performance verification test or adjustment.
- If all tests pass, you have a high confidence (~90%) that the N432A is operational.

The N432A troubleshooting mode self-test can be accessed via the front panel or remotely. The front panel softkey menu allows you to run individual test, whereas the remote command runs a full instrument self-test as listed in “[Remote testing](#)” on page 18.

Front panel selection of self-tests

Press  > **1 of 2** > **Service** > **Self Test** to access the **Self Test** menu that consists of the following tests:

- Instrument Self-Test
- Keyboard
- Bitmap Displays
- RTC Battery

Instrument self-test

When **Instrument Self Test** is selected, the following tests will be run: (These are the same tests run using the *TST? command.)

- Test Point Voltages
- Calibrator
- Fan
- RTC Battery
- V_{RF} Path
- V_{COMP} Path
- V_0 Path

2 Calibration Procedures

When **Run Self Test** is pressed, the N432A will check if the thermistor sensor is connected. If connected, you will be prompted to disconnect the sensor.

Once **Confirm** is pressed, the N432A will check if the sensor is disconnected. If disconnected, self-test will initiate and display the test results accordingly.

As each test takes place, the name of the test is listed on the screen. While a test is running, the message **Testing...** appears beside the name of the test. As each stage of the test completes, the **Testing...** message is replaced by either **Passed** or **Failed**.

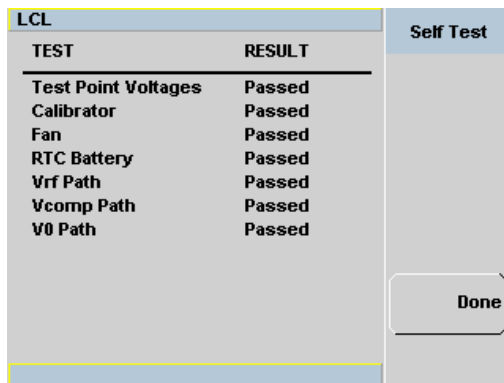

LCL		Self Test
TEST	RESULT	
Test Point Voltages	Passed	
Calibrator	Passed	
Fan	Passed	
RTC Battery	Passed	
Vrf Path	Passed	
Vcomp Path	Passed	
V0 Path	Passed	
		Done

Figure 2-1 Self-test completed

When the self-test has completed, press **Done** to return to the **Self Test** menu.

If the self-test failed, information about the failure will be displayed on the screen.

For any currently selected bridge resistance value of either 100 Ω , 200 Ω , 300 Ω , or 400 Ω , the internal self-test resistance value of 200 Ω will be used to perform the self-test.

When you press **Run Self Test** followed by **Confirm** even if the sensor is still connected, you will be prompted again to disconnect the sensor. If you cancel the sensor disconnect confirmation with the sensor still connected, tests for V_{RF} , V_{COMP} , and V_0 will be skipped and displayed as shown in [Figure 2-2](#).

LCL		ERR	Self Test
TEST	RESULT		
Test Point Voltages	Passed		Done
Calibrator	Passed		
Fan	Passed		
RTC Battery	Passed		
Vrf Path (Sensor connected)	Skipped		
Vcomp Path (Sensor connected)	Skipped		
V0 Path (Sensor connected)	Skipped		

Figure 2-2 V_{RF} , V_{COMP} , and V_0 tests skipped

Test descriptions

This section specifies what is actually checked by each test in the instrument self-test. Some of the tests may only be applicable to one method of invocation (for example, from the front panel). If this is the case, it is specified in the test description. Most of the tests have an associated error message which is added to the error queue if the test fails. The exception to this is the bitmap display test. For more information on the error messages, refer to the *N432A Thermistor Power Meter User's Guide*.

Test Point Voltages

An array of tests on various DC voltages inside the N432A.

Calibrator

The reference calibrator is turned on (indicated by the POWER REF LED) and measured internally. A pass or fail result is returned.

Fan

This test confirms that the internal cooling fan is running.

Real Time Clock (RTC) Battery

The RTC battery provides power for the real-time clock circuitry on the motherboard when the N432A is powered off.

During the RTC battery test, the RTC battery power level is determined by converting the ADC value of the RTC battery power level read from the FPGA, to voltage level. If the battery power level is less than a prespecified threshold (threshold to be defined later), the test will fail. An error will be logged in the error list if the test fails.

V_{RF} , V_{COMP} , V_0 Paths

An array of tests on the voltage metering for V_{RF} , V_{COMP} and V_0 . The built-in self-test circuit will output a set of known DC voltages to the bridge which are then compared to those measured by the N432A metering. This is a user-invoked self-test.

Remote testing

To perform a remote instrument self-test, the IEEE-488.2 common command *TST? is used. This command runs a full self-test and returns one of the following codes:

- 0 – no tests failed
- 1 – one or more tests failed

The communications assembly is tested implicitly, in that the command will not be accepted or return a result unless the remote interface is functioning correctly.

When the *TST? command is executed, the screen is cleared. As each test takes place, the name of the test is listed on the screen. While a test is running, the message **Testing...** appears beside the name of the test. As each stage of the test completes, the message **Testing...** is replaced by either **Passed** or **Failed**.

Performance Verification and Adjustments

Contact your local Keysight service centre to perform performance verification and adjustment on the N432A.

For more information, you can contact Keysight at the telephone numbers listed in **Contact us** on the back page. You can also use the following web link for information on contacting Keysight worldwide:

www.keysight.com/find/assist

or contact your Keysight representative.

THIS PAGE HAS BEEN INTENTIONALLY LEFT BLANK.

3

Service and Maintenance

Introduction	22
Service-Related Features	22
Cleaning	23
Checking the Power Line Fuses	23

This chapter contains general service and maintenance information for the N432A.

Introduction

This chapter provides the information on how to access service-related features on the N432A, as well as guidelines on how to clean the N432A and check the power line fuses.

Service-Related Features

NOTE

For more information on the following service-related features, refer to the *N432A Thermistor Power Meter User's Guide*.

To access the Service menu on the N432A, press  > **1 of 2** and select **Service**:

- Press **Self Test** to access the self-test menu which enables you to run individual test as described in “Self-Test” on page 15.
- Press **Version** to view the current firmware revision.
- Press **Secure Erase** to securely erase the N432A user-accessible memory.
- Press **Warm Start** to toggle On/Off the warm start feature. This feature allows you to retain the N432A current states and settings upon power cycle or in the event of interrupted power.
- Press **1 of 2** > **Display** to access the blank screen and secure blank features which enable you to secure data confidentiality.
- Press **Backlight** to access the backlight intensity control menu which allows you to increase or decrease the backlight brightness.

To view the error list on the N432A, press  and select **Error List**. Press **Next** to view the next error message and **Clear Errors** to clear the error list.

Cleaning

Power off the N432A and wipe its outer panels with a soft, lint-free, slightly dampened cloth. Do not use detergent. Disassembly is not required or recommended for cleaning.

Checking the Power Line Fuses

The power line fuses are located within the N432A fuse holder assembly on the rear panel. For all voltages, the N432A uses 250 V, T2.5 H, 20 mm slow blow fuses with high breaking capacity.

Use the following procedure to check the power line fuses:

- 1 Slide the fuse holder assembly from the rear panel as shown in the figure below.
- 2 The fuses should be positioned “in line” as shown below. Ensure that both fuses are operational.
- 3 Slide the fuse holder assembly back into the rear panel.

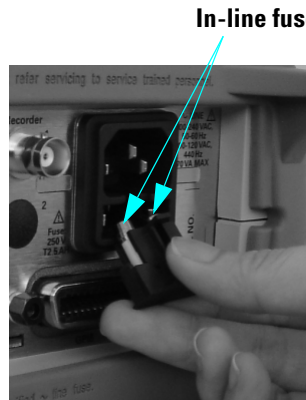

Figure 3-1 Checking the fuses

THIS PAGE HAS BEEN INTENTIONALLY LEFT BLANK.

4 Disassembly Guide

Introduction	26
Replaceable Parts	28
Tools Required	36
Required Torque Values	37
Disassembly Instructions	38
Reassembly Instructions	46
Front Panel Disassembly Instructions	47
Front Panel Reassembly Instructions	51
Improved Calibrator Assembly	54
Rear Panel Disassembly Instructions	55
Operating Checklist and Troubleshooting Hints	56

This chapter describes the removal and replacement of the assemblies in the N432A. It also lists the available N432A replacement parts together with their part numbers, as well as provides general troubleshooting hints.

Introduction

This chapter provides the information on some of the higher-level components and assemblies which can be ordered from Keysight Technologies. It also gives a step-by-step guide on how to assemble and disassemble the N432A for repair.

Once an assembly has been replaced, refer to **Chapter 2, Calibration Procedures** to ensure that correct performance tests and adjustments are carried out.

NOTE

The parts shown in the figures in the following sections are representative and may look different than what you have in your instrument.

General safety consideration

WARNING

- **Servicing instructions in this chapter should be performed by qualified personnel only. To avoid electric shock, do not perform any servicing unless you are qualified to do so.**
 - **Removal of covers or parts may expose dangerous voltages. Disconnect all voltage sources from the instrument prior to removal.**
 - **The detachable power cord is the instrument disconnecting device. It disconnects the main circuits from the main supply before other parts of the instrument. The front panel switch is only a standby switch and is not a LINE switch (disconnecting device).**
 - **This is a Safety Class 1 instrument (provided with a protective earth grounding incorporated in the power cord). The mains plug shall only be inserted in a socket outlet provided with a protective earth contact. Any interruption of the protective conductor inside or outside of the instrument is likely to make the instrument dangerous. Intentional interruption is prohibited.**
 - **If this instrument is not used as specified, the protection provided by the instrument could be impaired. This instrument must be used in a normal condition (in which all means for protections are intact) only.**
-

CAUTION

Most of the assemblies in this instrument are very susceptible to damage from electrostatic discharge (ESD). Perform service procedures only at a static-safe workstation and wear a grounding strap.

Replaceable Parts

Major assemblies

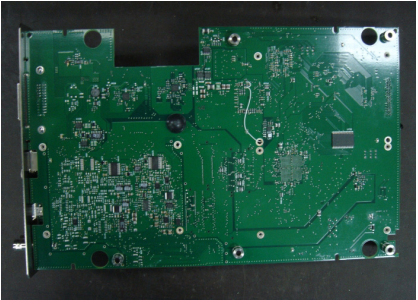
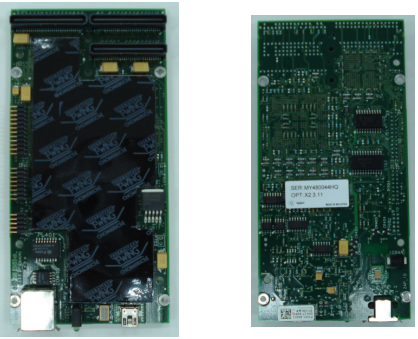

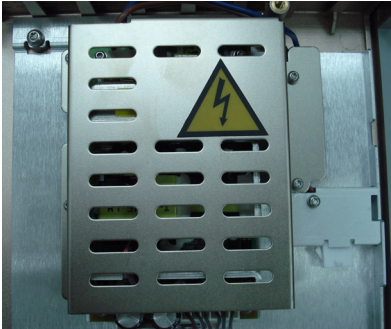
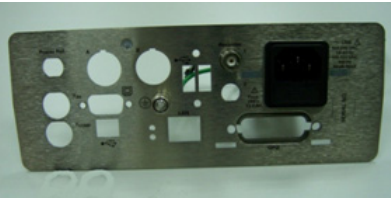
Keysight part number	Description	Visual
N1914-60200	Full front panel assembly	
N1913-66502	Motherboard	
N1913-66501	Processor PCI Mezzanine (PPMC) assembly Note: The ribbon cable (8121-1076) connecting the PPMC to the motherboard is supplied separately	



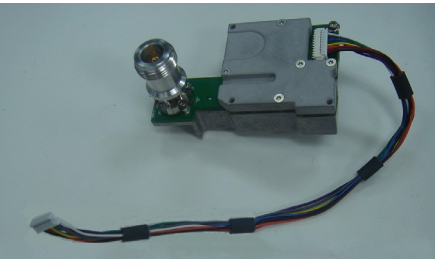

Keysight part number	Description	Visual
N1913-00100	Power supply unit (PSU)	
N432A-64401	Rear panel assembly	

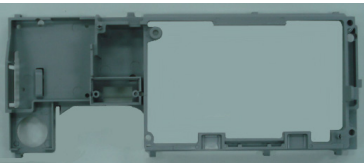
Front panel subassemblies

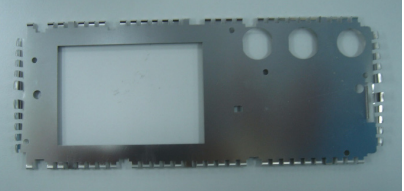
Keysight part number	Description	Visual
N1913-62000	<p>Calibrator assembly.</p> <p>For more information on the improved calibrator assembly, refer to “Improved Calibrator Assembly” on page 54.</p>	

4 Disassembly Guide

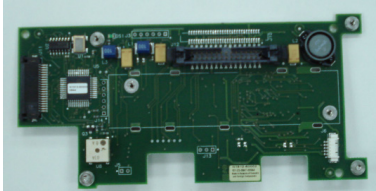
Keysight part number	Description	Visual
N1913-40200	Front panel frame	
N1913-36600	Front panel display support	
N1913-38300	Keypad	
N1912-20005	EMI shield	
N1913-00600	EMI screen	

Keysight part number	Description	Visual
2090-0825	LCD display	<p>Front view</p>  <p>Rear view</p> 
N1912-60002	Display interface board	
0950-4111	Inverter interface board	
N1912-61002	Backlight cable assembly	

4 Disassembly Guide

Keysight part number	Description	Visual
N1912-00038	EMC split washer	

Power supply unit (PSU) subassemblies

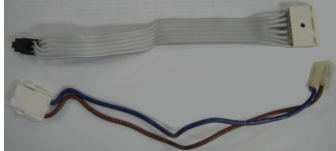
Keysight part number	Description	Visual
N1913-61301	PSU ribbon cable assembly	
N1913-61604	PSU main power connector	

Rear panel subassemblies



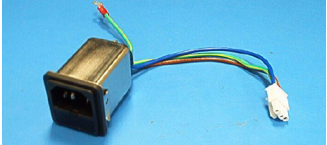

Keysight part number	Description	Visual
E4418-61015	Recorder output cable	

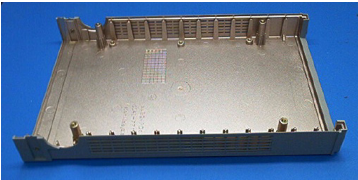
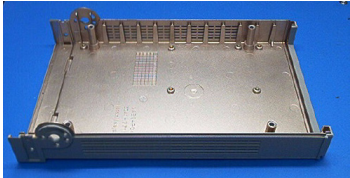
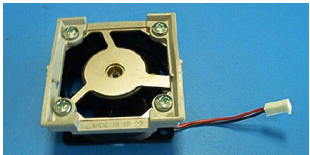

Keysight part number	Description	Visual
N1913-62700	Line module assembly	

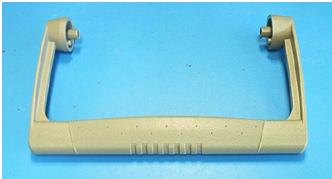
Other subassemblies

Keysight part number	Description	Visual
N1913-30100	Top clamshell	
5041-7718	Bottom clamshell	
N1912-61005	Fan assembly	

4 Disassembly Guide

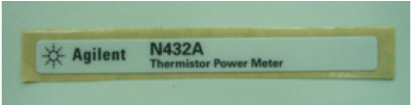
Keysight part number	Description	Visual
34401-86020	Bumper kit	
34401-45021	Handle	
6960-0081	BNC plug (rear panel)	
6960-0024	Sensor plug (front and rear panels)	
6960-0178	Calibrator plug (rear panel)	
N1913-36200	USB plug (front panel)	
N1913-36201	USB plug (rear panel)	
N1913-36202	VGA plug (rear panel)	
N1913-60283	V_{RF}/V_{COMP} cable	
N1912-21003	Calibrator plug	

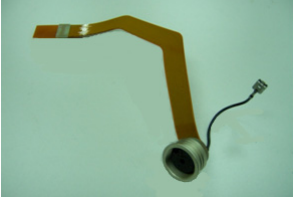
Keysight part number	Description	Visual
N432A-34300	Front panel label	
N432A-84300	Name plate	
8121-0936	Front panel ribbon cable	
N432A-67300	Sensor flex assembly	

Tools Required

Keysight part number	Description
N1911-61004 N1912-80005	<p>Three units of ¼" drive torque wrench</p> <ul style="list-style-type: none"> • one unit calibrated to 2.37 Nm • one unit calibrated to 1.02 Nm • one unit calibrated to 0.68 Nm <p>Three units of torque screwdriver</p> <ul style="list-style-type: none"> • one unit calibrated to 2.37 Nm • one unit calibrated to 0.56 Nm • one unit calibrated to 0.34 Nm <p>T6, T8, T10, and T20 Torx screwdriver bits</p> <p>7/16" break spanner, calibrated to 2.37 Nm</p> <p>5/16" break spanner, calibrated to 1.02 Nm</p> <p>9/32" socket calibrated to 2.37 Nm</p>
N1912-61807 (Special tooling kit)	<p>Contains:</p> <ul style="list-style-type: none"> • ODU socket • Trigger socket • 9/16" BNC socket <div data-bbox="648 1013 1076 1274" style="text-align: center;"> <p>The image shows three cylindrical metal sockets. From left to right: an ODU socket with a hexagonal base, a Trigger socket with a hexagonal base and a central hole, and a 9/16 inch BNC socket with a hexagonal base and a threaded end. Each socket is labeled with its name below it.</p> </div> <ul style="list-style-type: none"> • Sockets must be used in conjunction with a ¼" drive torque wrench, calibrated to 2.37 Nm • The 9/16" BNC socket is required to remove the recorder output fastener for the N432A • The trigger socket is required to remove the V_{RF} and V_{COMP} fasteners for the N432A

Required Torque Values

Required tools and torque values for fasteners are listed below:

Action	Required tool	Torque
Fit the rear panel GPIB standoffs	9/32" socket	2.37 Nm
Fit the rear panel V_{RF} and V_{COMP} connectors	Special tooling kit (N1912-61807)	2.37 Nm
Fit the rear panel recorder output connectors	7/16" spanner	2.37 Nm
Attach the motherboard to the clamshell	T20 screwdriver	2.37 Nm
Attach the PPMC assemblies to the motherboard	T8 screwdriver	0.56 Nm
Attach the earth wires (nut)	9/32" socket	1.02 Nm
Attach the earth wires (screw)	T20 screwdriver	2.37 Nm
Attach the top clamshell to the bottom clamshell	T20 screwdriver	2.37 Nm
Fit the sensor connector	Circlip pliers	–
Fit the PSU/PSU safety cover	T10 screwdriver	2.37 Nm
Fit the display-to-front frame display support	T6 screwdriver	0.56 Nm
Fit the calibrator-to-front frame display support	T6 screwdriver	0.34 Nm
Fit the display interface board-to-inverter board	T6 screwdriver	0.56 Nm

Disassembly Instructions

Follow the instructions in this section for the N432A disassembly process.

To remove the top clamshell

Instruction	Visual
<ul style="list-style-type: none"> Remove the handle: Rotate it to the vertical position. Pull both sides outwards from the N432A body. Remove the front and rear bumpers: Pull one side of the bumper outwards to disengage it. Pull it away from the N432A. Separate the clamshells (Figure 4-1): Use the T20 Torx screwdriver bit to loosen the four captive screws as indicated by the arrows. 	
<ul style="list-style-type: none"> Disconnect the mains power connector (Figure 4-2a) from the top clamshell. Disconnect the ribbon cable (Figure 4-2b) from the motherboard. Disconnect both earth spade connectors (Figure 4-2c) from the top clamshell. Remove the top clamshell. 	

Figure 4-1 Separate the clamshells

Figure 4-2 Remove the top clamshell

To remove the power supply unit (PSU)

Instruction	Visual
<ul style="list-style-type: none"> Remove the top clamshell (refer to To remove the top clamshell). Remove the PSU safety cover (Figure 4-3): Use the T10 Torx screwdriver bit to remove the four screws attaching the PSU safety cover to the top clamshell as indicated by the arrows. Lift and remove the safety cover. 	 <p>Figure 4-3 Remove the PSU safety cover and cable guide</p>
<ul style="list-style-type: none"> Disconnect the ribbon cable assembly from the PSU (Figure 4-4a). Disconnect the mains power connector from the PSU (Figure 4-4b). Use the T10 Torx screwdriver bit to remove the four screws attaching the PSU to the top clamshell, as indicated by the arrows in Figure 4-4. Lift and remove the PSU. 	 <p>Figure 4-4 Remove the PSU</p>

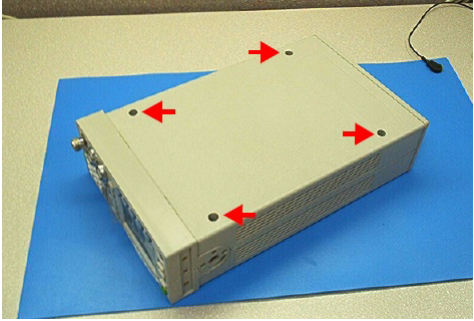
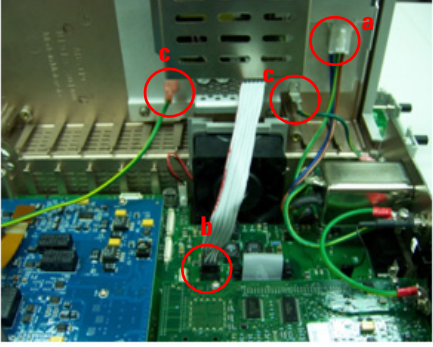
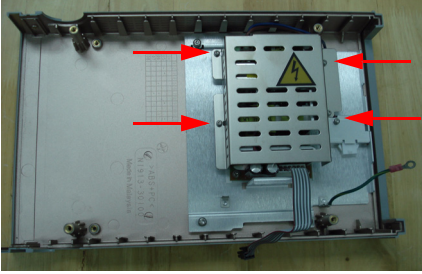
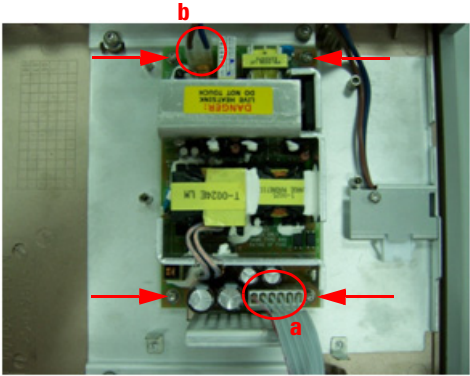
To remove the front panel assembly

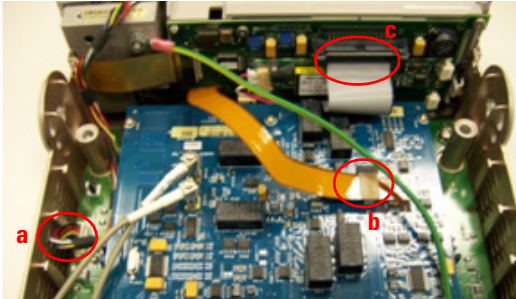
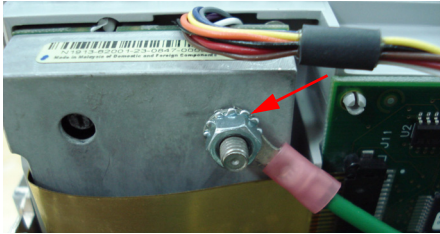
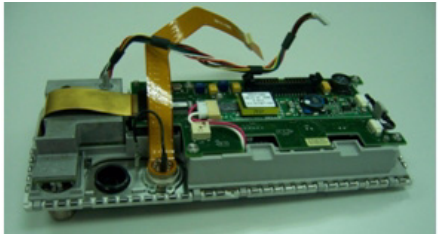
Instruction	Visual
<ul style="list-style-type: none"> Remove the top clamshell (refer to To remove the top clamshell). Disconnect the calibrator assembly cable (Figure 4-5a) from the motherboard. Disconnect the sensor flex circuit (Figure 4-5b) from the measurement board. Disconnect the front panel cable (Figure 4-5c): Depress both sides of the connector holding the ribbon cable to eject it. 	 <p>Figure 4-5 Top view with top clamshell removed</p>
<ul style="list-style-type: none"> Remove the EMI earth cable (Figure 4-6): Use the 9/32" socket to remove the hex nut attaching the EMI earth cable to the calibrator assembly, as indicated by the arrow. Remove the EMI earth cable and washers, taking note of the assembly order. 	 <p>Figure 4-6 Remove the EMI earth wires</p>
<ul style="list-style-type: none"> Carefully lift and remove the front panel assembly (Figure 4-7). 	 <p>Figure 4-7 Remove the front panel assembly</p>

NOTE

For the procedure to disassemble the front panel assembly, refer to **“Front Panel Disassembly Instructions”** on page 47.

To remove the measurement board

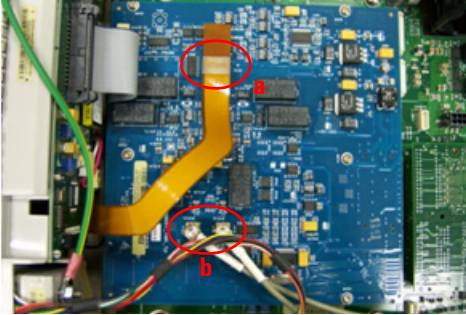
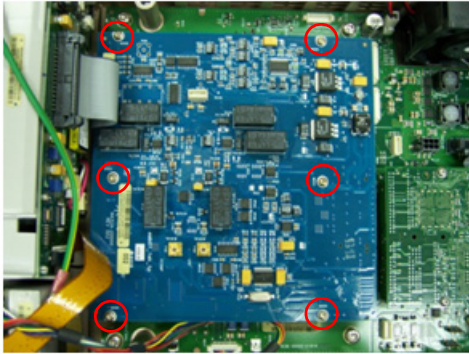
Instruction	Visual
<ul style="list-style-type: none"> Remove the top clamshell (refer to To remove the top clamshell). Disconnect the sensor flex cable (Figure 4-8a) from the measurement board. Disconnect the V_{RF} and V_{COMP} cables (Figure 4-8b) from P100 and P102 on the measurement board respectively. 	 <p>Figure 4-8 Disconnect the sensor flex cable and V_{RF} and V_{COMP} cables</p>
<ul style="list-style-type: none"> Use the T8 Torx screwdriver bit to remove the six screws attaching the measurement board to the motherboard, as indicated by the circles (Figure 4-9). Lift and remove the measurement board. 	 <p>Figure 4-9 Remove the measurement board</p>

To remove the PPMC assembly

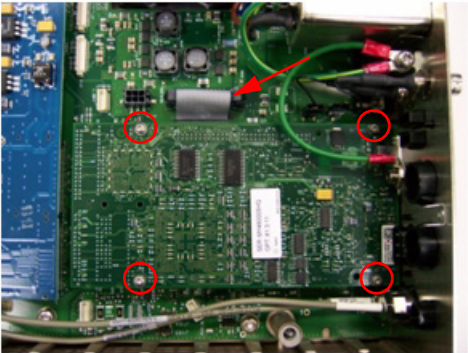
Instruction	Visual
<ul style="list-style-type: none"> Remove the top clamshell (refer to To remove the top clamshell). Disconnect the ribbon cable (Figure 4-10): Depress both sides of the connector holding the ribbon cable to eject it, as indicated by the arrow. Use the T8 Torx screwdriver bit to remove the four screws attaching the PPMC assembly to the motherboard, as indicated by the circles (Figure 4-10). Lift and remove the measurement board. 	 <p>Figure 4-10 Remove the PPMC assembly</p>

NOTE

- Always perform firmware upgrade for the N432A when the PPMC assembly has been replaced.
- The N432A serial number is stored in the PPMC assembly. To enter the N432A original serial number, send the following command:
SERV:SNUM <character_data>

To remove the fan assembly

Instruction	Visual
<ul style="list-style-type: none"> Remove the top clamshell (refer to To remove the top clamshell). Disconnect the fan assembly cable from the motherboard, as indicated by the circle (Figure 4-11). Lift and remove the fan assembly. 	 <p data-bbox="654 664 1053 696">Figure 4-11 Remove the fan assembly</p>

To remove the motherboard

Instruction	Visual
<ul style="list-style-type: none"> Remove the top clamshell (refer to To remove the top clamshell). Remove the measurement board (refer to To remove the measurement board). Remove the PPMC assembly (refer to To remove the PPMC assembly). Remove the fan assembly (refer to To remove the fan assembly). Disconnect the calibrator assembly cable (Figure 4-12a) from the motherboard. Disconnect the front panel cable (Figure 4-12b): Depress both sides of the connector holding the ribbon cable to eject it. 	 <p data-bbox="654 1229 1253 1289">Figure 4-12 Disconnect the calibrator assembly and front panel cables</p>

4 Disassembly Guide

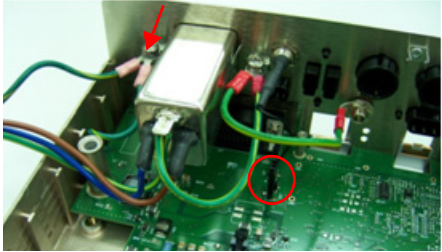
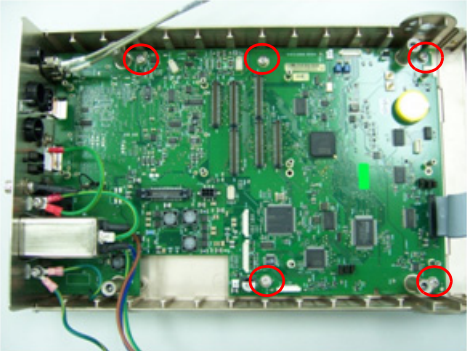
Instruction	Visual
<ul style="list-style-type: none">• Disconnect the recorder cable from J30 on the motherboard, as indicated by the circle (Figure 4-13).• Use the T20 Torx screwdriver bit to remove the screw attaching the earth cables to the line module, as indicated by the arrow (Figure 4-13). Remove the earth cables and washers, taking note of the assembly order.	 <p>Figure 4-13 Disconnect the recorder cable and remove the earth cables and washers</p>
<ul style="list-style-type: none">• Remove the motherboard and rear panel assembly (Figure 4-15): Use the T20 Torx screwdriver bit to remove the five screws attaching the motherboard to the bottom clamshell, as indicated by the circles. Lift and remove the motherboard and rear panel assembly from the bottom clamshell.	 <p>Figure 4-14 Remove the motherboard and rear panel assembly</p>

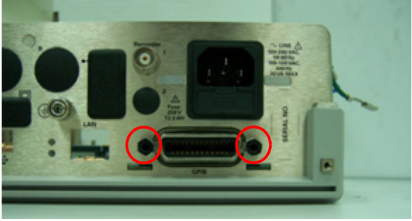
Instruction	Visual
<ul style="list-style-type: none">Remove the rear panel assembly (Figure 4-15): Use the 9/32" socket to remove the GPIB standoffs, as indicated by the circles. Carefully pull the rear panel away from the motherboard.	 <p data-bbox="654 548 1122 576">Figure 4-15 Remove the rear panel assembly</p>

NOTE

For the procedure to disassemble the rear panel assembly, refer to “[Front Panel Disassembly Instructions](#)” on page 47.

Reassembly Instructions

The reassembly process is simply the reverse of the disassembly process.

For the procedure to re-assemble the front panel assembly, refer to “[Front Panel Reassembly Instructions](#)” on page 51.

Front Panel Disassembly Instructions

CAUTION

- Front panel disassembly should only be performed in a clean and dust-free environment.
- Failure to do so may introduce contamination between the EMI shielded window and the display.
- It may not be necessary to completely disassemble the front panel in order to repair or replace some of its parts. As such, this procedure should be tailored to suit the specific repair requirements.

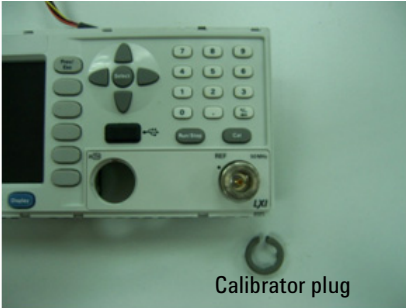
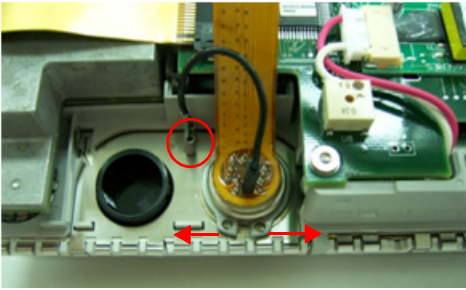
Instruction	Visual
<ul style="list-style-type: none"> • Remove the front panel assembly (refer to “To remove the front panel assembly” on page 40). • Gently lift and remove the calibrator plug. This step is only applicable for calibrator assembly with the calibrator plug. For more information on the improved calibrator assembly, refer to “Improved Calibrator Assembly” on page 54. 	
<ul style="list-style-type: none"> • Remove the sensor flex assembly: Unplug the cable connecting the sensor flex circuit to the front panel, as indicated by the circle. Use circlip pliers to open up and remove the retainer ring, in the direction indicated by the arrows. Gently pull the sensor flex assembly from the front panel. Note: The sensor flex assembly is supplied straight. Do not bend the sensor flex circuit. • Route and connect the sensor flex assembly. Once the sensor flex assembly has been attached to the N432A, do not bend the sensor flex circuit. 	

4 Disassembly Guide

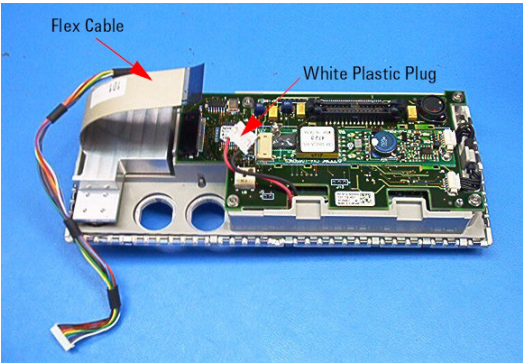
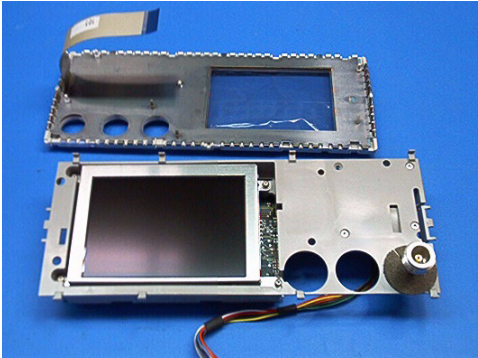
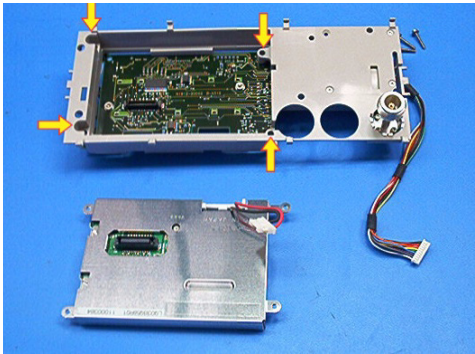
Instruction	Visual
<ul style="list-style-type: none">• Release the tab holding the flex cable to the display interface board, and then disconnect it.• Disconnect the white plastic plug from the display interface board. <ul style="list-style-type: none">• Unlock the main plastic clip (situated beside the key flex circuit) that holds the front panel sub-frame and display support moulding together. Carefully pull them apart. <ul style="list-style-type: none">• Remove the four screws attaching the display to the display support moulding, as indicated by the arrows.• Disconnect the cable from the display interface board.	 <p>The image shows the display interface board with a flex cable and a white plastic plug. Red arrows point to the 'Flex Cable' and the 'White Plastic Plug'.</p>  <p>The image shows the front panel sub-frame and display support moulding being pulled apart.</p>  <p>The image shows the display being removed from the display support moulding. Yellow arrows point to the four screws attaching the display to the moulding.</p>

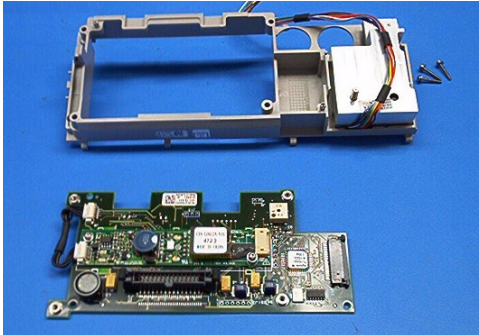
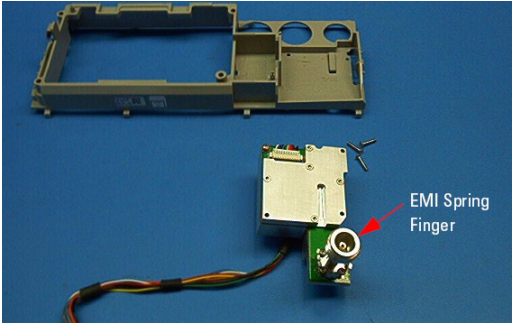
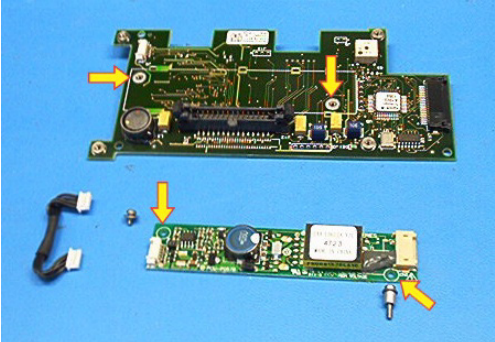
Instruction	Visual
<ul style="list-style-type: none"> Lift the display interface board off the plastic mounting lugs on the display support molding to separate them from one another. 	 <p>The image shows a grey plastic display support molding with a white display interface board attached to its right side. Below it, the display interface board is shown separately, a green PCB with various components and connectors.</p>
<ul style="list-style-type: none"> Remove the three screws attaching the calibrator assembly to the display support moulding. Separate them from one another. Take care not to damage the EMI spring fingers on the calibrator assembly. 	 <p>The image shows the display support molding with the calibrator assembly being removed. A red arrow points to a component on the calibrator assembly labeled "EMI Spring Finger".</p>
<ul style="list-style-type: none"> Disconnect the backlight cable assembly from the display interface board and inverter board. Remove the two screws attaching the display interface board to the inverter board. Separate them from one another. 	 <p>The image shows the display interface board and the inverter board. Yellow arrows point to the two screws that attach the display interface board to the inverter board. A backlight cable assembly is also shown to the left.</p>

4 Disassembly Guide

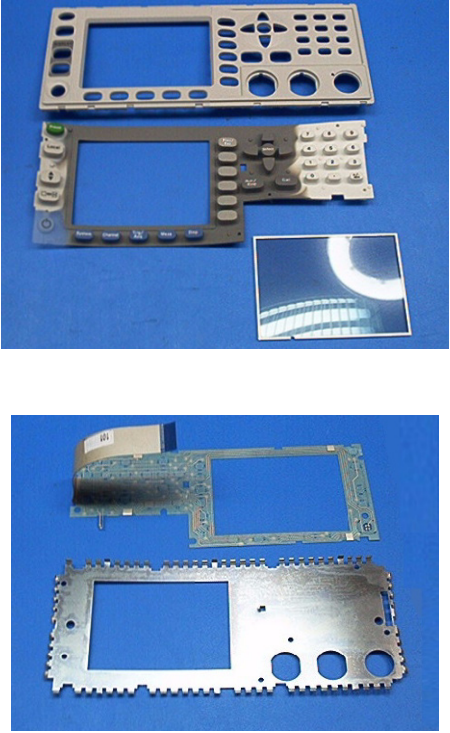

Instruction	Visual
<ul style="list-style-type: none">• Release the metal tabs attaching the EMI screen to the front panel sub-frame. Separate them from one another.• Disengage the rubber tabs attaching the key flex circuit to the key mat. Lift and remove the key flex circuit. <ul style="list-style-type: none">• Remove the EMI shielded window and the key mat from the front panel sub-frame.	 <p>The top photograph shows two views of the front panel sub-frame. The top view shows the sub-frame with the EMI screen and key mat removed. The bottom view shows the sub-frame with the EMI shielded window and key mat removed. The bottom photograph shows the EMI shielded window and key mat removed from the front panel sub-frame.</p>

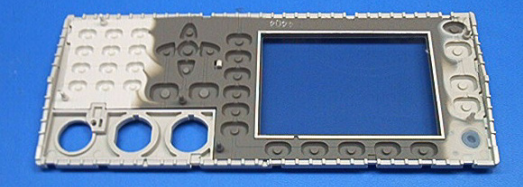
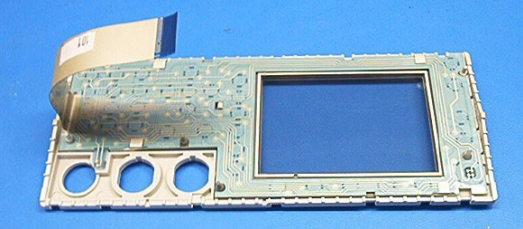
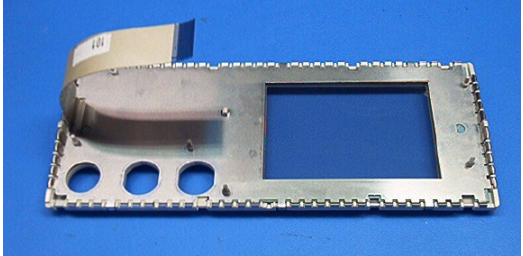
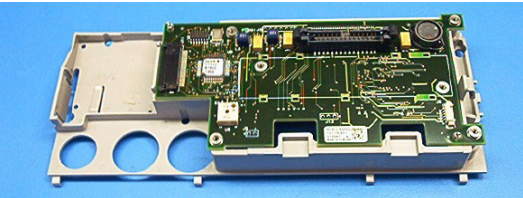
Front Panel Reassembly Instructions

Instruction	Visual
<ul style="list-style-type: none"> • Attach the key mat into the front panel subframe. • Attach the EMI shielded window into the key mat. Ensure that the EMI shielded window is clean and free from fingerprints. 	
<ul style="list-style-type: none"> • Overlay the key flex circuit onto the key mat. Ensure that all the rubber lugs are engaged to hold the key flex circuit securely. 	
<ul style="list-style-type: none"> • Overlay the EMI screen onto the key flex circuit. Ensure that all the metal tabs are engaged to hold the EMI screen securely. 	
<ul style="list-style-type: none"> • Attach the display interface board onto the plastic mounting lugs on the display support moulding. 	

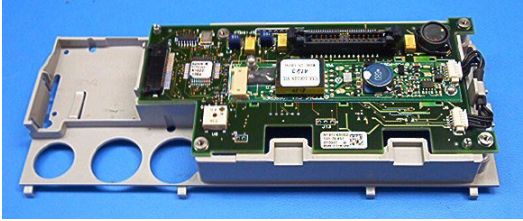
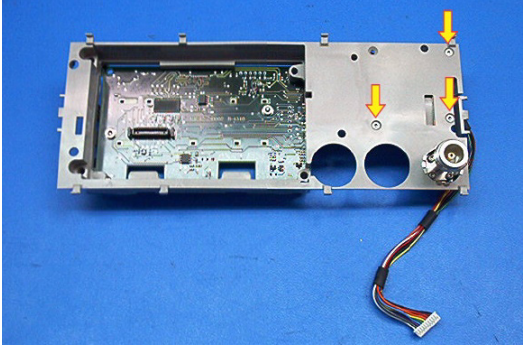
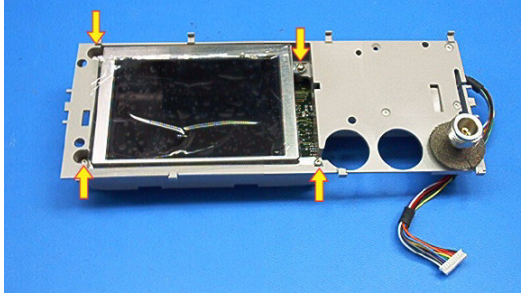
4 Disassembly Guide

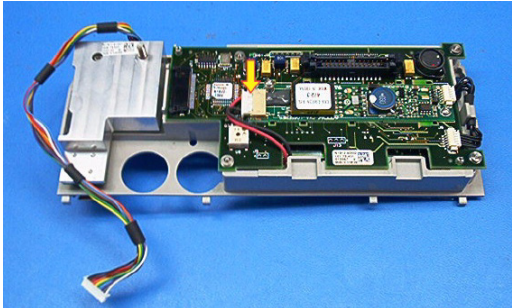
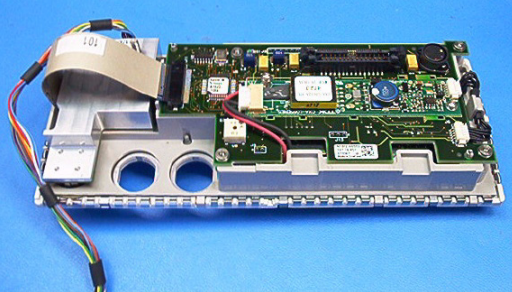
Instruction	Visual
<ul style="list-style-type: none">• Attach the inverter board to the display interface board using the two screws removed earlier.• Connect the inverter board to the display interface board using the backlight cable assembly. Ensure that the cable is tucked under the plastic clips to prevent any fouling.	 A photograph showing a green printed circuit board (PCB) with various electronic components, including a transformer and capacitors. The board is mounted on a silver metal frame. A multi-colored ribbon cable is connected to the board. The assembly is shown against a blue background.
<ul style="list-style-type: none">• Attach the calibrator assembly to the display support moulding using the three screws removed earlier, as indicated by the arrows.• Carefully spread the EMI fingers outwards. Ensure that they extend beyond the edges of the hole in which the calibrator assembly is fitted.	 A photograph of a silver metal calibrator assembly. It features a circular hole on the right side. Three yellow arrows point to the top edge of the assembly, indicating where screws should be attached. A multi-colored ribbon cable is connected to the bottom right. The background is blue.
<ul style="list-style-type: none">• Fit the split washer to the calibrator assembly.• Attach the LCD display to the display interface board using the four screws removed earlier, as indicated by the arrows.	 A photograph showing the LCD display panel being attached to the display interface board. The display is a dark, rectangular panel. Four yellow arrows point to the corners of the display, indicating the locations for screws. The assembly is shown against a blue background.

Instruction	Visual
<ul style="list-style-type: none"> • Connect the white plastic plug to the display interface board, as indicated by the arrow. 	  
<ul style="list-style-type: none"> • Attach the front panel subframe to the display support moulding. Ensure that all plastic clips are engaged to hold the front panel subframe securely. • Connect the flex cable to the display interface board and tighten the locking tab. 	
<ul style="list-style-type: none"> • Re-fit the calibrator plug. • This step is only applicable for calibrator assembly with the calibrator plug. • For more information on the improved calibrator assembly, refer to “Improved Calibrator Assembly” on page 54. 	

Improved Calibrator Assembly

The N432A calibrator assembly is improved with a new type-N calibrator connector for a better fit with the front panel assembly as shown in [Figure 4-16](#). The calibrator plug (N1912-21003) will not be needed with the improved calibrator assembly.

NOTE

The N432A performance will not be affected with the improved calibrator assembly.

Calibrator assembly



Improved calibrator assembly

Figure 4-16 Calibrator assembly and improved calibrator assembly

Rear Panel Disassembly Instructions

- Remove the motherboard (refer to “To remove the motherboard” on page 43).
- Remove the V_{RF} or V_{COMP} output connector: Use the trigger socket in the N1912-61807 special tooling kit to remove the fastener attaching the V_{RF} or V_{COMP} output connector to the rear panel assembly. Carefully pull the V_{RF} or V_{COMP} output connector away from the rear panel assembly.
- Remove the recorder output connector: Use the 9/16" BNC socket to remove the fastener attaching the recorder output connector to the rear panel assembly. Carefully pull the recorder output connector away from the rear panel assembly.

Operating Checklist and Troubleshooting Hints

This section provides general troubleshooting hints to detect failures for the N432A.

General problems

Problem	Basic check	Possible fault
Unable to power up the N432A	<ul style="list-style-type: none"> • Verify that the mains power source is live • Verify that the mains fuse is operational • Check the mains cable for any obvious damage • Verify that the line module fuse in the N432A is operational • Check/reseat the cable between the line module and the PSU • Check/reseat the cable between the PSU and the motherboard 	<ul style="list-style-type: none"> • The PSU is defective • The cable (between the line module and the PSU or between the PSU and the motherboard) is defective • The key flex circuit is defective • The front panel cable is loose • The motherboard is defective
The N432A is unable to detect the connected sensor	Verify with a different thermistor sensor and sensor cable	<ul style="list-style-type: none"> • The sensor flex assembly is defective • The measurement board is defective • The motherboard is defective
GPIB communication interface failure	Verify with a different GPIB connectivity medium such as a GPIB cable	<ul style="list-style-type: none"> • The GPIB connectivity medium is defective • The motherboard is defective
USB/LAN communication interface failure	Check/reseat the ribbon cable connecting the PPMC to the motherboard	<ul style="list-style-type: none"> • The ribbon cable is defective • The PPMC assembly is defective • The motherboard is defective

Instrument self-test failures

Test	Purpose	Debug tip	Possible fault
Test point voltages	Verifies that all of the supply voltages are present	Replace the PSU to determine if this clears the faults	<ul style="list-style-type: none"> • The PSU is defective (low probability) • The motherboard is defective (high probability)
Calibrator	Verifies that the reference calibrator is working (Note: This test does not verify if the calibrator meets its specifications)	<ul style="list-style-type: none"> • Check/reseat the cable between the calibrator assembly and the motherboard • Attempt to adjust the 1 mW power reference level 	<ul style="list-style-type: none"> • The calibrator assembly is defective (high probability) • The motherboard is defective (low probability)
Fan	Verifies that the internal cooling fan is working	<ul style="list-style-type: none"> • Check/reseat the cable between the fan assembly and the motherboard • Check visually if the fan is functioning 	<ul style="list-style-type: none"> • The fan assembly is defective (high probability) • The motherboard is defective (low probability)
Real time clock (RTC) battery	Verifies that the lithium manganese battery on the motherboard is working	Replace the battery to determine if this clears the fault	<ul style="list-style-type: none"> • The lithium manganese battery is defective (high probability) • The motherboard is defective (low probability)
V_{RF} , V_{COMP} , and V_0 paths	Verifies the internal DC voltages in comparison to the voltages measured by the N432A metering	Attempt to calibrate the N432A	The motherboard is defective

Extended self-test failures

Test	Purpose	Debug tip	Possible fault
Keyboard	Verifies the operation of every key (apart from the power button)	Not applicable	Front panel (the keymat or key flex circuit is defective)
Bitmap display	Verifies that all pixels in the display can be illuminated in various colors	Not applicable	Front panel (the display, display interface board, or inverter board is defective)
RTC battery	Verifies that the lithium manganese battery on the motherboard is working	Replace the battery to determine if this clears the fault	<ul style="list-style-type: none"> • The lithium manganese battery is defective (high probability) • The motherboard is defective (low probability)

Performance test failure

Test	Debug tip	Possible fault
Instrument accuracy	Attempt to adjust the instrument accuracy	The motherboard is defective

5

Specifications and Characteristics

Introduction	60
N432A Specifications	62
Rear Panel Input and Output Connections	64
1 mW Power Reference	65
Environmental Conditions	66
Physical Characteristics	67
Regulatory Information	68

This chapter describes the specifications and characteristics of your N432A.

Introduction

This chapter details the N432A specifications and supplemental characteristics.

Specification definitions

There are two types of product specifications:

- Warranted specifications
- Characteristic specifications

Warranted specifications

Warranted specifications are covered by the product warranty and applied after a 30-minute warm-up. These specifications are valid over the N432A operating and environmental ranges unless otherwise stated, and after performing zeroing.

Characteristic specifications

Supplemental characteristics which are specified in italics are intended to provide information useful in applying to the N432A by giving typical, but non-warranted performance parameters. These characteristics are specified in *italics* or denoted as “*typical*”, “*nominal*”, or “*approximate*”.

Characteristic information is representative of the product. In many cases, it may also be supplemental to a warranted specification. Characteristic specifications are not verified on all products. The types of characteristic specifications can be placed in two groups:

- The first group of characteristic types describes 'attributes' common to all products of a given model or option.

Examples of characteristics that describe 'attributes' are product weight and 50 Ω input Type-N connector. In these examples, the product weight is an *approximate* value and the 50 Ω input is *nominal*. These two terms are most widely used when describing 'attributes' of a product.

- The second group of characteristic types describes 'statistically' the aggregate performance of the population of products.

These characteristics describe the expected behavior of the population of products. They do not guarantee the performance of any individual product. No measurement uncertainty value is accounted for in the specifications. These specifications are referred to as *typical*.

Conditions

The N432A with a thermistor sensor meet its specifications when:

- stored for a minimum of two hours at a stable temperature within the operating temperature range, and turned on for at least 30 minutes.
- the N432A and the thermistor sensor are within their recommended calibration periods.
- used in accordance to the information provided in this guide.

N432A Specifications

Frequency range

100 kHz to 18 GHz, thermistor-sensor dependent

Power range

-30 dBm to +10 dBm (1 μ W to 10 mW), thermistor-sensor dependent

Thermistor sensor compatibility

- Keysight 478A thermistor sensor (with Option H63, H75, and H76)
- Keysight 8478B thermistor sensor

Meter power accuracy

Absolute power accuracy: \pm (0.1% of reading + 0.5 μ W)

Meter voltage accuracies (1-year reference specifications)

- V_{RF} and V_{COMP} : $23^{\circ}\text{C} \pm 5^{\circ}\text{C}$: $\pm(0.0035\% + 50 \mu\text{V})$ [reading + range]
- V_0 and V_1 : $23^{\circ}\text{C} \pm 5^{\circ}\text{C}$: $\pm(0.0040\% + 25 \mu\text{V})$ [reading + range]

Bridge resistance

Selectable resistances of 100, 200, 300, and 400 Ω

Single sensor dynamic range

40 dB maximum (Keysight 478A and 8478B thermistor sensors)

Display units

- Power: Absolute – Watts (W) or dBm, Relative – Percent (%) or dB
- V_{RF} and V_{COMP} : VDC
- V_0 and V_1 : VDC and mVDC
- Bridge resistance: Ohm

Display resolutions

- Power: Selectable resolutions of 1, 0.1, 0.01, and 0.001 dBm in logarithmic mode, or 1, 2, 3, and 4 significant digits in linear mode
- Voltage: 6.5-digit resolution
- Bridge resistance: 6.5-digit resolution

Default resolution

0.01 dBm in logarithmic mode or three significant digits in linear mode

Rear Panel Input and Output Connections

Recorder output	Analog 0 to 1 V, 1 k Ω output impedance, BNC connector
GPIB USB 2.0 10/100 BaseT LAN	These interfaces allow communication with an external controller
V_{RF} and V_{COMP} outputs	BNC terminals which output the RF and compensation bridge voltages that can be used for precision power measurements
Ground	Binding post, accepts 4 mm plug or bare wire connection

Line power

Input voltage range	100 – 240 Vac, automatic selection 220 – 240 V \pm 10%
Input frequency range	50 – 60 Hz, 400 Hz 400 Hz (100 – 120 Vac)
Power requirement	70 VA

1 mW Power Reference

Power output	1.00 mW (0.0 dBm)
Accuracy	$\pm 1.2\%$ (0 – 45°C) $\pm 0.4\%$ (25 $\pm 10^\circ\text{C}$)
Frequency	<i>50 MHz nominal</i>
SWR	1.08 maximum
Connector type	Type N (f), 50 Ω

Environmental Conditions

General

The N432A complies with the requirements of the EMC Directive 89/336/EEC. The N432A is designed for indoor use only.

Operating environment

Operating temperature	0°C to 45°C
Operating humidity	15% to 95% at 40°C (non-condensing)
Altitude	Up to 4600 m (15000 ft.)

Storage

Storage temperature	-40°C to +70°C
Storage humidity	Up to 90% relative humidity at 65°C (non-condensing)

Physical Characteristics

Dimensions

The following dimensions exclude front and rear panel protrusions:

- 212.6 mm W x 88.5 mm H x 348.3 mm D
(8.5 in x 3.5 in x 13.7 in)

Weight

Weight (net)	≤ 3.70 kg (approximately)
Weight (shipping)	≤ 8.30 kg (approximately)

Regulatory Information

Electromagnetic (EM) compatibility

The N432A complies with the essential requirements of the following applicable European (EC) Directives, and carries the CE marking accordingly to the Low Voltage Directive (2006/95/EC) and EMC Directive (2004/108/EC).

EMC tests conform to the IEC 61326-2-1:2005/EN 61326-2-1:2006 and CISPR 11:2003/EN 55011:2007 (Group 1, Class A). In order to preserve the EMC performance of the N432A, any cable which becomes worn or damaged must be replaced with the same type and specification.

The N432A also meets the following EMC standards:

- Canada: ICES-001:2004
- Australia/New Zealand: AS/NZS CISPR11:2004

Degradation of some instrument specifications can occur in the presence of ambient EM fields and noise that are coupled to the power line or I/O cables of the N432A. The N432A will self-recover and operate to all specifications when the source of ambient EM fields and noise are removed or when the N432A is protected from the ambient EM fields or when the N432A cabling is shielded from the ambient EM noise.

Product safety

The N432A conforms to the requirements of the following safety standards:

- IEC 61010-1:2001/EN 61010-1:2001
- CAN/CSA-C22.2 No.61010-1-04
- ANSI/UL61010-1:2004

Low voltage directive

The N432A conforms to the requirements of the European Council Directive "2006/95/EC".

Contact us

To obtain service, warranty, or technical assistance, contact us at the following phone or fax numbers:

United States:

(tel) (800) 829 4444 (fax) 800 829 4433

Canada:

(tel) (877) 894 4414 (fax) 800 746 4866

China:

(tel) 800 810 0189 (fax) 800 820 2816

Europe:

(tel) 31 20 547 2111

Japan:

(tel) 0120 (421) 345 (fax) 0120 421 678

Korea:

(tel) 080 769 0800 (fax) (080) 769 0900

Latin America:

(tel) 305 269 7500

Taiwan:

(tel) 0800 047 866 (fax) 0800 286 331

Other Asia Pacific Countries:

(tel) (65) 6375 8100 (fax) (65) 6755 0042

Or visit Keysight World Wide Web at:

www.keysight.com/find/assist

Product specifications and descriptions in this document are subject to change without notice. Always refer to the Keysight Web site for the latest revision.

This information is subject to change without notice.
© Keysight Technologies 2010–2014
Edition 6, August 2014



N432A-90005
www.keysight.com